

Quick Installation Guide

Data Logger

Logger1000



Validity

This manual is valid for the following data loggers.

- Logger1000A (4G version)
- Logger1000B (non-4G version)

The foregoing Loggers are referred to as the "Logger1000" for short unless otherwise specified.

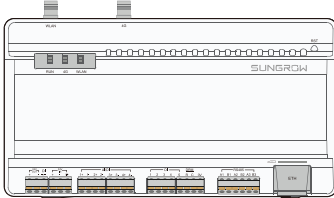

Logger1000A

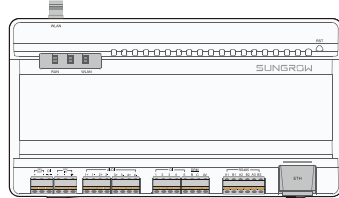

Logger1000B

Safety

1. Contents may be periodically updated or revised due to product development. The information in this guide is subject to change without notice. In no case shall this guide substitute for the user manual or related notes on the device.
2. Make sure to read over, fully understand and strictly follow the detailed instructions of the user manual and other related regulations. Scan the bottom QR Code of the cover to view or obtain the user manual.
3. All operations can be performed only by qualified personnel, that must be trained in the installation and commissioning of the electrical system, as well as the dealing with hazards, have knowledge of the manual and of the local regulations and directives.
4. Before installation, check that the package contents are intact and complete against the packing list. Contact SUNGROW or the distributor in case of any damaged or missing components.
5. The cable must be intact and well insulated. Operation personnel must wear proper personal protective equipment (PPE) all the time.
6. Any violation could result in personal death or injury or device damage, and will void the warranty.

EU Declaration of Conformity

within the scope of the EU directives



- Restriction of the use of certain hazardous substances 2011/65/EU and 2015/863/EU (RoHS)
- The radio equipment directive 2014/53/EU (RED)

SUNGROW confirms herewith that the products described in this document are in compliance with the fundamental requirements and other relevant provisions of the abovementioned directives. The entire EU Declaration of Conformity can be found at support.sungrowpower.com.

Radio technology	WLAN 802.11b/g/n20/n40	
Radio spectrum	802.11b/g/n20	2412 MHz ~ 2472 MHz
	802.11n40	2422 MHz ~ 2462 MHz
Maximum transmission power	≤ 20 dBm	

Technical parameters listed above apply to EU countries only.

Gültigkeit

Dieses Handbuch gilt für die folgenden Datensammler.

- Logger1000A (4G Version)
- Logger1000B (Nicht-4G Version)

Die vorstehenden Logger werden, wenn nicht anders angegeben, kurz als „Logger1000“ bezeichnet.

Sicherheit

1. Die Inhalte können aufgrund der Produktentwicklung regelmäßig aktualisiert oder überarbeitet werden. Die Informationen in diesem Handbuch können ohne vorherige Ankündigung geändert werden. In keinem Fall ersetzt diese Anleitung das Benutzerhandbuch oder zugehörige Hinweise auf dem Gerät.
2. Lesen Sie die Anweisungen im Benutzerhandbuch und andere damit zusammenhängende Bestimmungen vollständig und sorgfältig durch und befolgen Sie diese strikt. Scannen Sie den QR-Code auf der Unterseite des Deckels, um die ausschließlich abzurufen und anzeigen zu lassen.
3. Alle Arbeiten dürfen nur von qualifiziertem Personal ausgeführt werden, das in der Installation und Inbetriebnahme der elektrischen Anlage sowie im Umgang mit Gefahren geschult wurde und über Kenntnis des Benutzerhandbuchs sowie der örtlichen Vorschriften und Richtlinien verfügt.
4. Vergewissern Sie sich vor der Installation, dass der Paketinhalt gemäß der Packliste vollständig und funktionsfähig ist. Wenden Sie sich bei beschädigten oder fehlenden Komponenten an SUNGROW oder den Händler.
5. Das Kabel muss intakt und gut isoliert sein. Das Bedienungspersonal muss stets geeignete Schutzausrüstung (PSA) tragen.
6. Das Nichteinhalten von Anweisungen kann zu Tod oder Verletzungen von Menschen oder zu Schäden am Gerät führen und hat ein Erlöschen der Garantie zur Folge.

EU-Konformitätserklärung

im Rahmen der EU-Richtlinien



- Beschränkung der Verwendung bestimmter gefährlicher Stoffe 2011/65/EU und 2015/863/EU (RoHS)
- Funkanlagen-Richtlinie 2014/53/EU (RED)

SUNGROW bestätigt hiermit, dass die in diesem Dokument beschriebenen Produkte den grundlegenden Anforderungen und anderen einschlägigen Bestimmungen der vorstehenden Richtlinien entsprechen. Die vollständige EU-Konformitätserklärung kann unter support.sungrowpower.com abgerufen werden.

Funktechnik	WLAN 802.11b/g/n20/n40	
Funkspektrum	802.11b/g/n20 802.11n40	2,412–2,472 GHz 2,422–2,462 GHz
Maximale Übertragungsleistung	≤ 20 dBm	

Die vorstehenden technischen Parameter gelten nur für EU-Länder.

Validité

Ce manuel s'applique aux collecteurs de données suivants.

- Enregistreur1000A (version 4G)
- Enregistreur1000B (non version 4G)

Les enregistreurs susmentionnés seront désignés ci-après « Enregistreur1000 », sauf mention contraire.

Sécurité

1. Le contenu peut être périodiquement mis à jour ou révisé en raison du développement constant du produit. Les informations contenues dans ce guide sont soumises à des modifications sans préavis. En aucun cas ce guide n'a pas pour objet de remplacer le manuel utilisateur ou les notes relatives à l'appareil.
2. Assurez-vous de lire attentivement, de comprendre dans leur ensemble et de strictement suivre les instructions détaillées du manuel utilisateur et des autres réglementations qui y sont liées. Scannez le code QR sur le dessous du capot pour afficher ou obtenir le manuel utilisateur.
3. Toutes les opérations peuvent être uniquement réalisées par du personnel qualifié qui doit être formé à l'installation et à la mise en service du système électrique, ainsi qu'à la gestion des risques, et qui connaît le manuel ainsi que les réglementations et les directives locales.
4. Avant l'installation, veuillez vérifier que le contenu du package est intact et complet en le comparant à la liste de conditionnement. Contactez SUNGROW ou le distributeur en cas de composants endommagés ou absents.
5. Le câble doit être intact et bien isolé. Le personnel opérationnel doit porter un équipement de protection individuelle approprié (EPI) à tout moment.
6. Toute violation pourrait entraîner un préjudice corporel ou la mort, ou des dommages sur l'appareil, et annulera la garantie.

Déclaration UE de conformité
dans le cadre des directives de l'UE



- Limitation de l'utilisation de certaines substances dangereuses 2011/65/UE et 2015/863/EU (RoHS)
- La directive sur les équipements radioélectriques 2014/53/UE (RED)

SUNGROW confirme par la présente que les produits décrits dans ce document sont conformes aux exigences fondamentales et aux autres dispositions pertinentes des directives susmentionnées. Pour consulter l'intégralité de la déclaration UE de conformité, rendez-vous sur support.sungrowpower.com.

Technologie radio	WLAN 802.11b/g/n20/n40	
Spectre radioélectrique	802.11b/g/n20	2 412 MHz ~ 2 472 MHz
	802.11n40	2 422 MHz ~ 2 462 MHz
Puissance de transmission maximale	≤ 20 dBm	

Les paramètres techniques indiqués ci-dessus s'appliquent uniquement aux pays de l'UE.

Validade

Este manual é válido para os seguintes coletores de dados.

- Logger1000A (versão 4G)
- Logger1000B (versão não 4G)

Os Agentes de logs anteriores são chamados de "Logger1000", a menos que especificado de outra forma.

Segurança

1. O conteúdo pode ser periodicamente atualizado ou revisado devido ao desenvolvimento de produtos. As informações contidas neste guia estão sujeitas a alterações sem aviso prévio. Sob nenhuma circunstância este guia deve substituir o manual do usuário ou avisos relacionados no dispositivo.
2. Assegure de ler, entender e seguir rigorosamente as informações detalhadas no manual do usuário e outras regulamentações anteriores. Verifique o Código QR inferior da capa para ver ou obter o manual do usuário.
3. Todas as operações podem só ser realizadas por pessoal qualificado, que deve ser treinado em como instalar e comissionar do sistema elétrico, e também em como lidar com perigos, ter conhecimento do manual e das normas e diretivas locais.
4. Antes de instalar, verifique se o conteúdo da embalagem está intacto e completo na lista da embalagem. Entre em contato com a SUNGROW ou com o distribuidor em caso de componentes danificados ou faltando.
5. Cabo deve estar intacto e bem isolado. O pessoal da operação deve usar equipamento de proteção individual (EPI) o tempo todo.
6. Qualquer violação pode causar ferimentos, morte ou ferimentos ou danos ao dispositivo e anulará a garantia.

Declaração de conformidade da UE
no âmbito das diretivas da UE



- Restrição da utilização de determinadas substâncias perigosas 2011/65/UE e 2015/863/UE (RoHS)
- Diretiva de equipamentos de rádio (RED) 2014/53/EU

A SUNGROW confirma que os produtos descritos neste documento estão em conformidade com os requisitos fundamentais e outras disposições relevantes das diretivas supramencionadas. Pode consultar a Declaração de Conformidade UE na íntegra em support.sungrowpower.com.

Radiotecnologia	WLAN 802.11b/g/n20/n40		
Espectro radioelétrico	802.11b/g/n20	2412 MHz ~ 2472 MHz	
	802.11n40	2422 MHz ~ 2462 MHz	
Potência de transmissão máxima	≤ 20 dBm		

Os parâmetros técnicos listados acima aplicam-se apenas a países da UE.

1. Typical Application/ Typische Anwendung/ Application type/ Aplicação típica

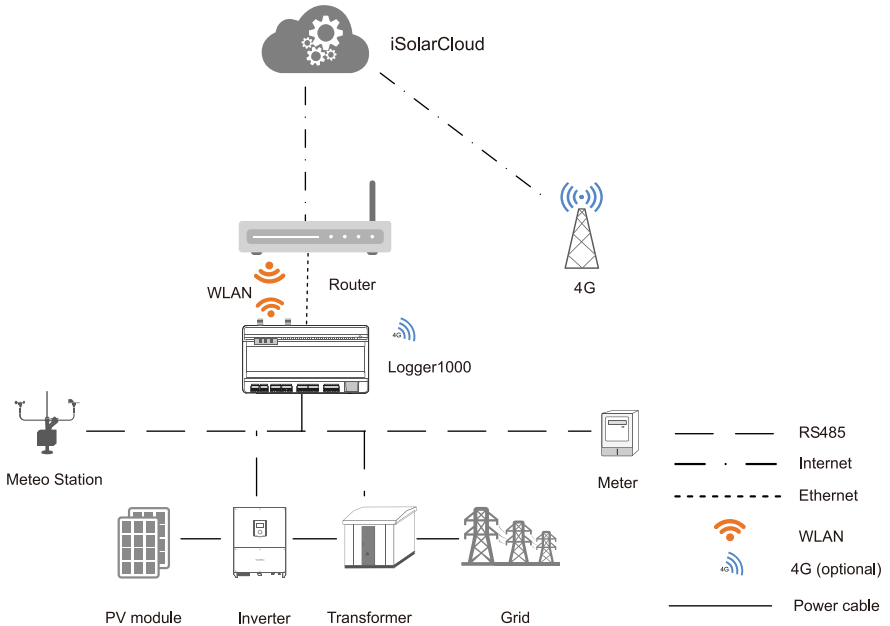

⚠ NOTICE

- The Logger1000 can be connected to iSolarCloud via any or a combination of Ethernet, WLAN and 4G.

2. Mechanical Installation/ Mechanische Installation/ Installation mécanique/ Instalação mecânica

2.1 Installation Location/ Standortanforderungen/ Exigence liée à l'emplacement/ Requisitos de localização

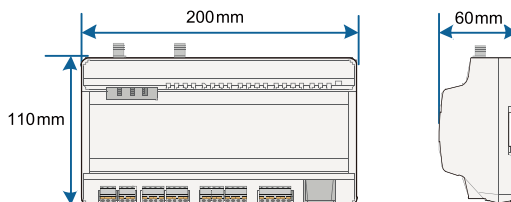
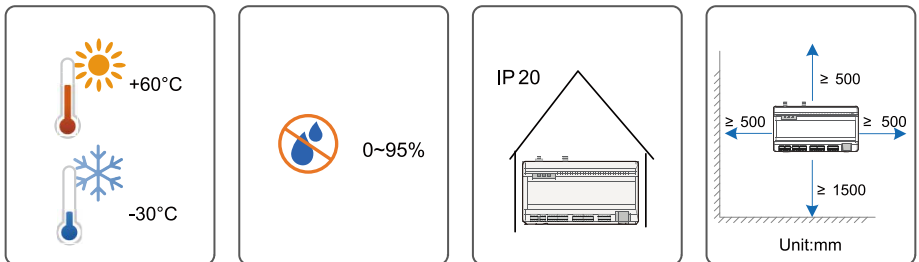

2.2 Guide Rail-Mounting/ Montage der Führungsschiene/ Installation sur le rail de guidage/ Montagem de régua de guia

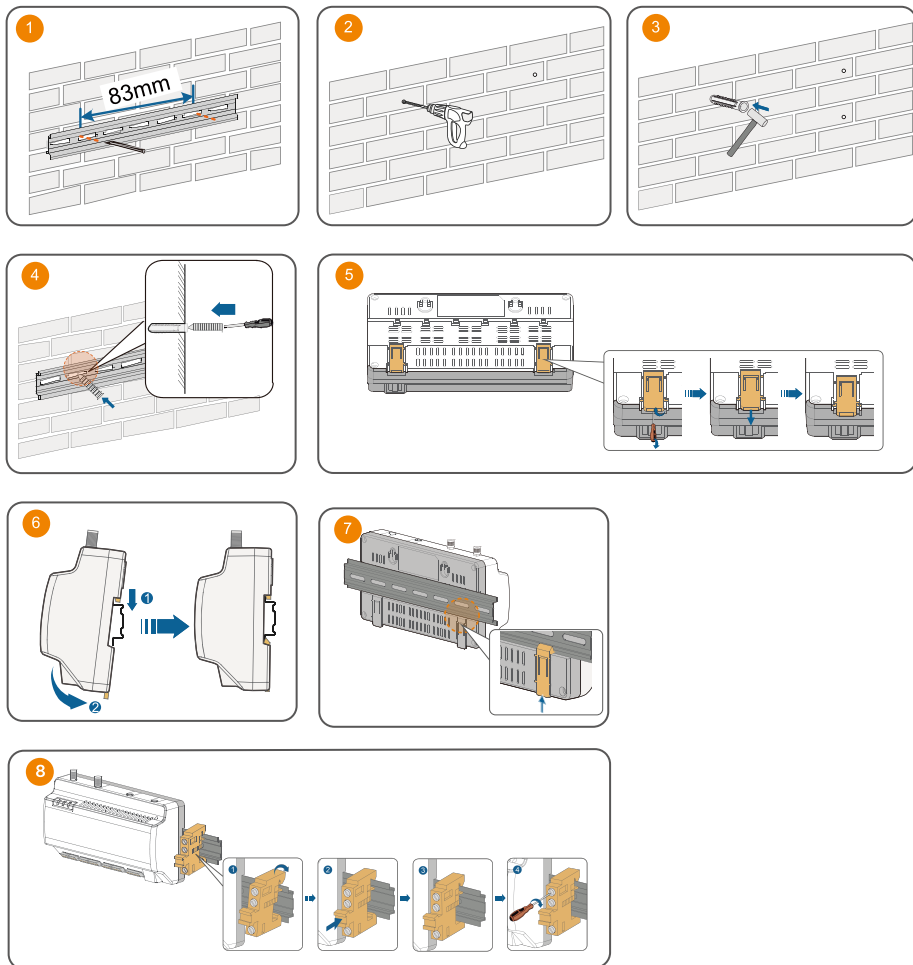

2.3 Installing Antenna/ Antenneninstallation/ Installation de l'antenne/ Instalação da antena

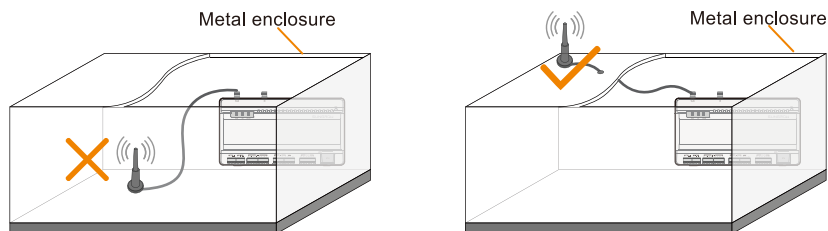

2.4 Installing Power Box/ Installation der Power-Box/ Installation de la boîte d'alimentation/ Instalação da caixa de energia

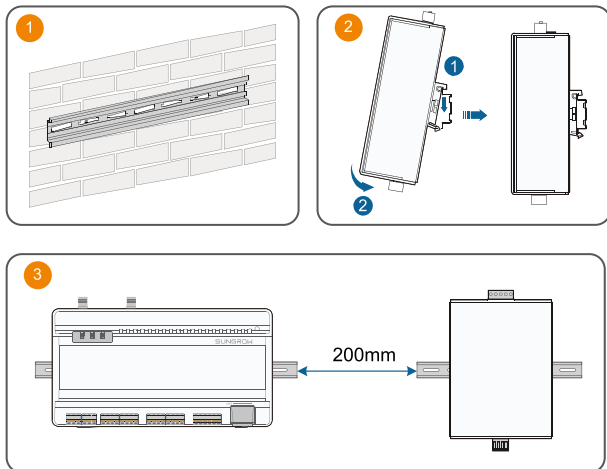

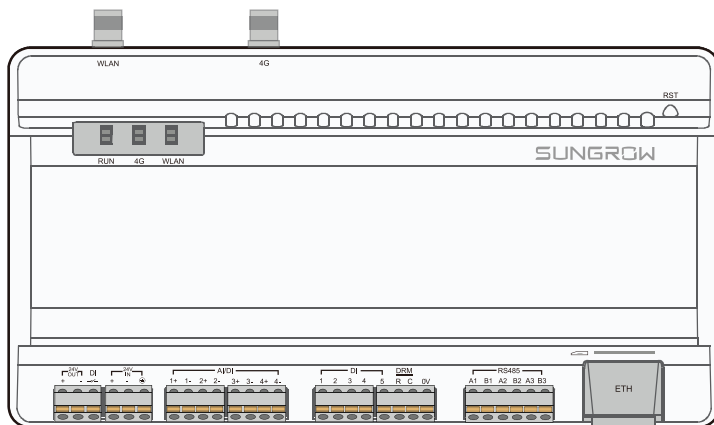

3. Electrical Connection/ Elektrische Verbindungen/ Raccordements électriques/ Conexão elétrica

3.1 Port Introduction/ Einweisung zu den Ports/ Présentation du port/ Introdução da porta



Tab. 3-1 Port description

Port(print)	Function	Description
24V OUT	24V power output	24V±5%, the max. output current: 0.5A
DI	Converters AI into DI	Switch for enabling the AI/DI function
24V IN	24V power input	24V±3%
	Grounding	Connecting protective grounding cable
AI/DI	Analog input	Default AI input sampling: 0-10V or 4-20mA
DI	Digital input	Digital signal input
DRM	Demand Response Modes function	-
0V	Digital reference point	-
RS485	RS485 communication port	Support of 3 inputs of RS485
 *	SIM card slot	Support of Micro-SIM card
ETH	Ethernet port	Can be connected to background master via devices such as Ethernet switch and router
WLAN	WLAN antenna	-
4G*	4G antenna	-
RST	Reset	Press it for 3s to reset

- Note: * Only the Logger1000A is equipped with the SIM card slot and the 4G function.

Tab. 3-2 Indicator description

Indicator (print)	LED color	LED status	Description
Running indicator (RUN)	Red/green	Off	No external power supply connected
		Slow flash (Green)	Normal running
		Slow flash (Red)	Device alarm
		Steady on (Red)	Logger1000 running fault
4G indicator (4G)*	Blue	Off	No data communication
		Steady on	4G connected successfully
		Slow flash	Data communication in process
WLAN indicator (WLAN)	Blue	Off	No data communication
		Steady on	WiFi connected successfully
		Slow flash	Data communication in process

- Note: * Only the Logger1000A is equipped with the 4G indicator.

3.2 Connection to PV Devices/ Anschluss an PV-Geräte/ Connexion aux appareils photovoltaïques/ Conexão a dispositivos fotovoltaicos

- 3.2.1 Connection to a single inverter/ Verbinden mit einem einzelnen Wechselrichter/ Connexion à un onduleur individuel/ Conexão a um único inversor

The RS485 port of SUNGROW inverter is RS485 terminal block or RJ45 port.

- RS485 terminal block connection

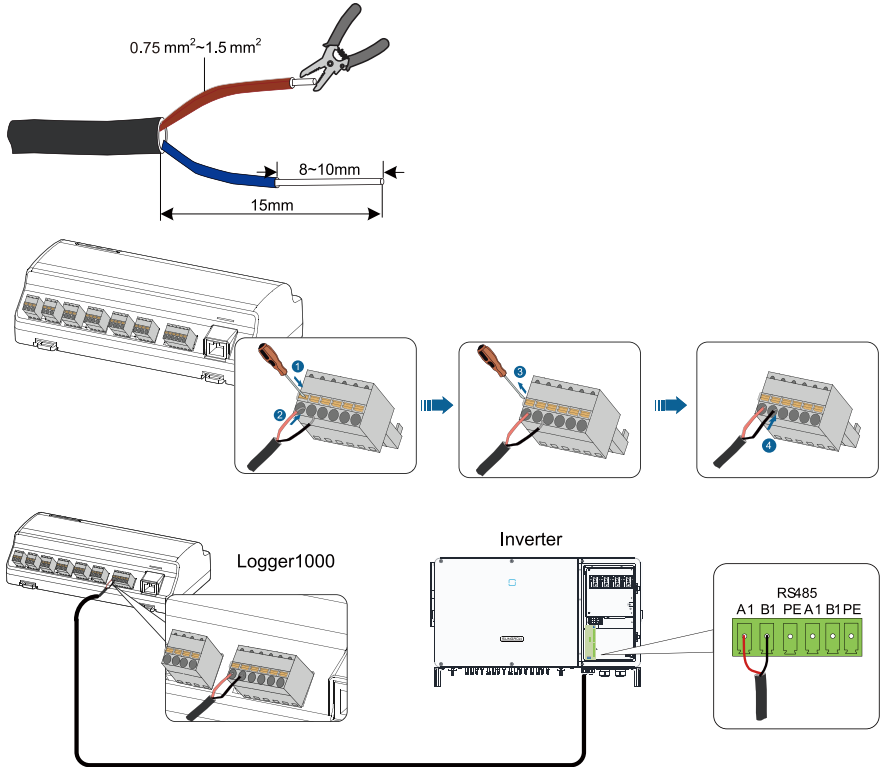

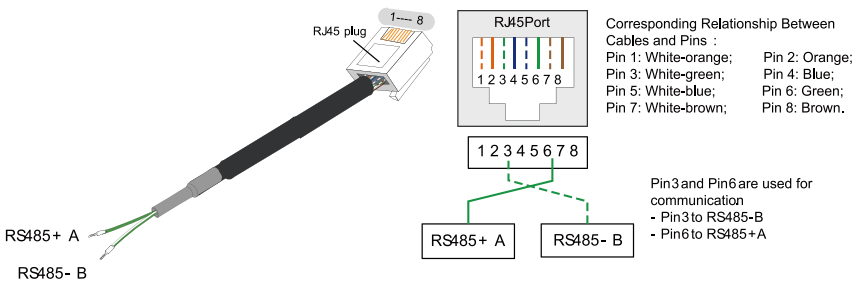

- RJ45 port connection

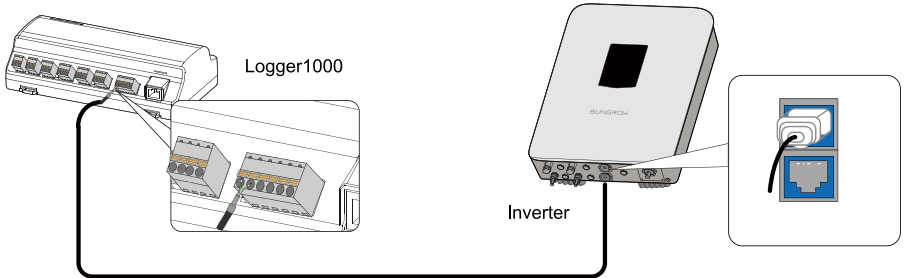
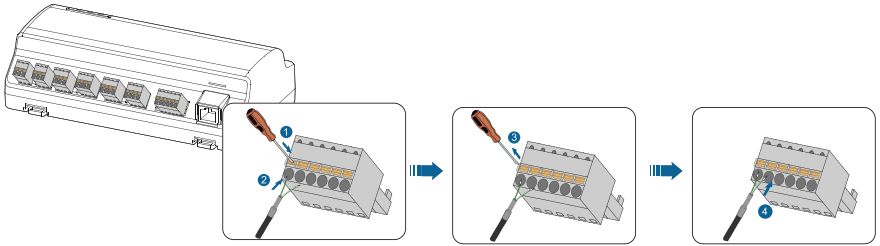

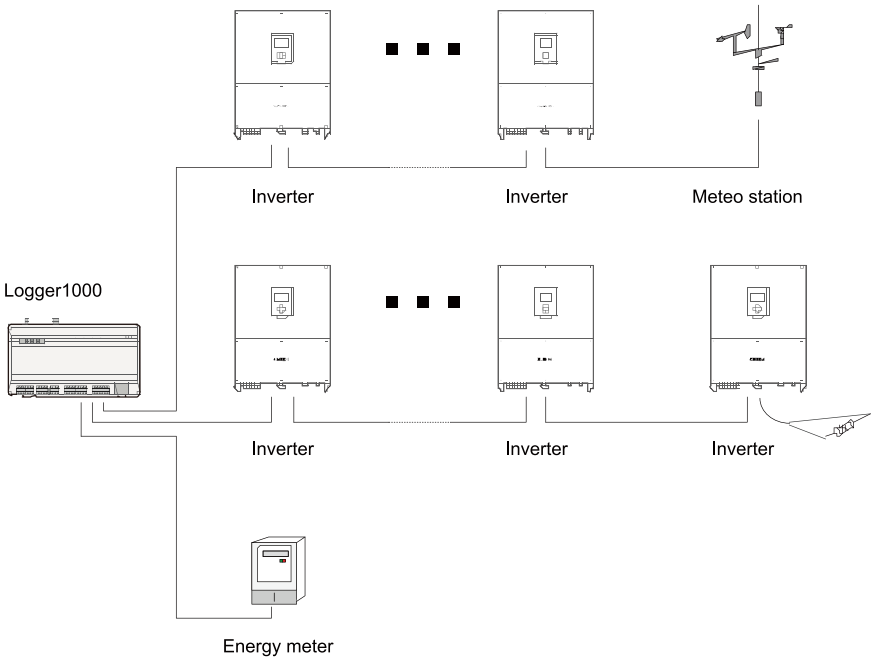

- 3.2.2 Connection to multiple devices/ Verbinden mit mehreren Geräte/ Connexion à plusieurs appareils/ Conexão a vários dispositivos



 NOTICE

- Multiple inverters are connected to the Logger1000 in the RS485 daisy chain manner.
- If more than 15 inverters are connected on the RS485 bus, it is recommended to connect a 120 Ω terminal resistor in parallel on the RS485A and RS485B lines at the head or tail end of the bus.
- When the number of device types is less than or equal to the number of RS485 ports of Logger1000, it is recommended to connect different types of devices to different RS485 ports separately.

 HINWEIS

- Mehrere Wechselrichter werden am Logger1000 über eine RS485-Verkettung angeschlossen.
- Wenn mehr als 15 Wechselrichter an den RS485-Bus angeschlossen sind, wird empfohlen, an den RS485A- und RS485B-Leitungen am Kopf oder am Ende des Busses einen 120- Ω -Abschlusswiderstand parallel zu schalten.
- Wenn die Anzahl der Gerätetypen kleiner oder gleich der Anzahl der RS485-Ports des Logger1000 ist, wird empfohlen die unterschiedlichen Gerätetypen jeweils separat an verschiedenen RS485-Ports anzuschließen.

 AVIS

- Plusieurs onduleurs sont connectés à l'Enregistreur100 via le RS485 installé en série.
- Si plus de 15 onduleurs sont connectés sur le bus RS485, il est recommandé de connecter une résistance de borne de 120 Ω en parallèle aux lignes RS485A et RS485B sur le devant ou l'arrière du bus.
- Lorsque le nombre de types d'appareil est inférieur ou égal au nombre de ports RS485 du Logger1000, il est recommandé de brancher des types d'appareil différents à des ports RS485 distincts séparément.

 AVISO PRÉVIO

- Múltiplos inversores são conectados ao Logger1000 da forma encadeada do RS485.
- Se mais de 15 inversores estiverem conectados no barramento RS485, recomenda-se conectar um resistor de terminal de 120 Ω em paralelo nas linhas RS485A e RS485B na cabeça ou na extremidade traseira do barramento.
- Se o número de tipos de dispositivos for menor ou igual ao número de portas RS485 do Logger1000, é recomendado ligar os diversos tipos de dispositivos a diferentes portas RS485, em separado.

3.3 Connection to Background/ Verbindung zum Hintergrund/ Connexion à l'arrière-plan/ Conexão ao fundo

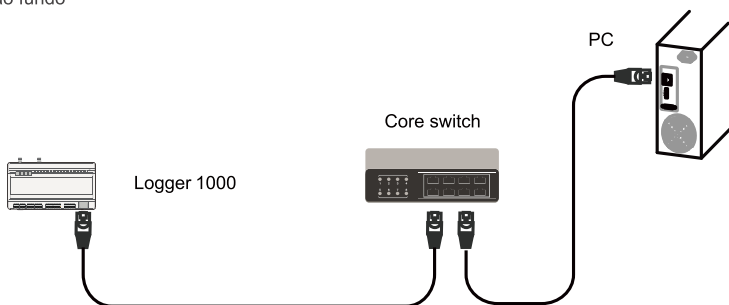

NOTICE

- Default IP of the "ETH":12.12.12.12.

3.4 Connection to Micro-SIM/ Verbindung zur Micro-SIM/ Connexion à Micro-SIM/ Conexão ao Micro-SIM

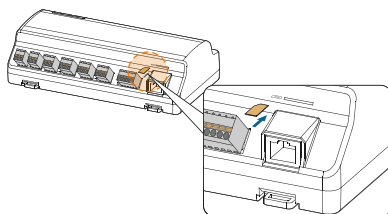

NOTICE

- Support of hot plug of Micro-SIM.

3.5 Connection to Power Box/ Anschließen an das Power Box/ Connexion à boîte de électrique/ Conexão ao caixa de energia

DC cable

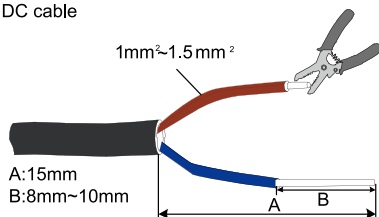

AC cable

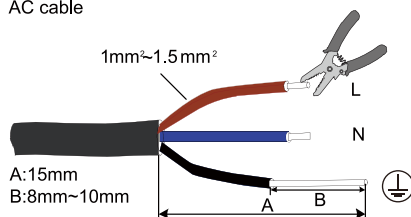

Grounding cable

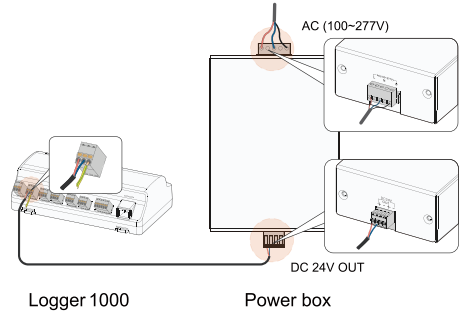
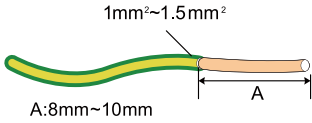

4.Commissioning/ Inbetriebnahme/ Mise en service/ Comissionamento

1

AC(100~277V)
Power box

2

RUN 4G WLAN

3

WLAN
SG-A123456789
SG-A1111111111
SG-A222222222
11.11.11.1
S/N: A123456789
Logger1000A

4

Logger1000

5

11.11.11.1
Start menu
Login
Username: pw1111
Password: 0.0000
Login

6

iSolarCloud IEC104 MODBUS Third-party Portal Echnet
Server: kit.isolarcloud.com Peer Port: 10999 Switch:

Logger1000 Advanced Settings
Server: kit.isolarcloud.com
Chinese Server
International Server
European Server
Australian Server

Region	Station
Mainland China	Chinese Server
Europe	European Server
Australia	Australian Server
Others	International Server

7 Use the iSolarCloud App to create a new plant

11.11.11.1
S/N: A123456789
Logger1000A

Quick Guidance of iSolarCloud App





More information in the QR code or
at <http://support.sungrowpower.com>

